

E528 4G 24VAC Wiring Guide

INNtool Support Material: Wiring 24VAC

Disclaimer

This document contains information that is the proprietary and confidential property of INNCOM by Honeywell. By acceptance hereof, each recipient agrees to use the information contained herein only for the purpose anticipated by INNCOM by Honeywell, and not to disclose to others, copy or reproduce, any part hereof without the written consent of INNCOM by Honeywell. The recipient agrees to return this document to INNCOM by Honeywell immediately upon request.

- **DISCONNECT POWER BEFORE BEGINNING INSTALLATION. ELECTRICAL HAZARD:** Can cause electrical shock or equipment damage.
- **Must be installed by a trained , experienced technician.**
- **See device specific product guides for load specifications.**

Table of Contents

1. WIRING GUIDE 24VAC.....	2
2. THERMOSTAT WIRE CONNECTIONS:	2
3. SYSTEM SPECIFIC WIRING GUIDES.....	3
4. LOW VOLTAGE WIRING	5
5. DOCUMENT INFORMATION	6

1. Wiring Guide 24VAC Power Supply (“A3” option)

See detailed wiring guides for specific system types on the following page.

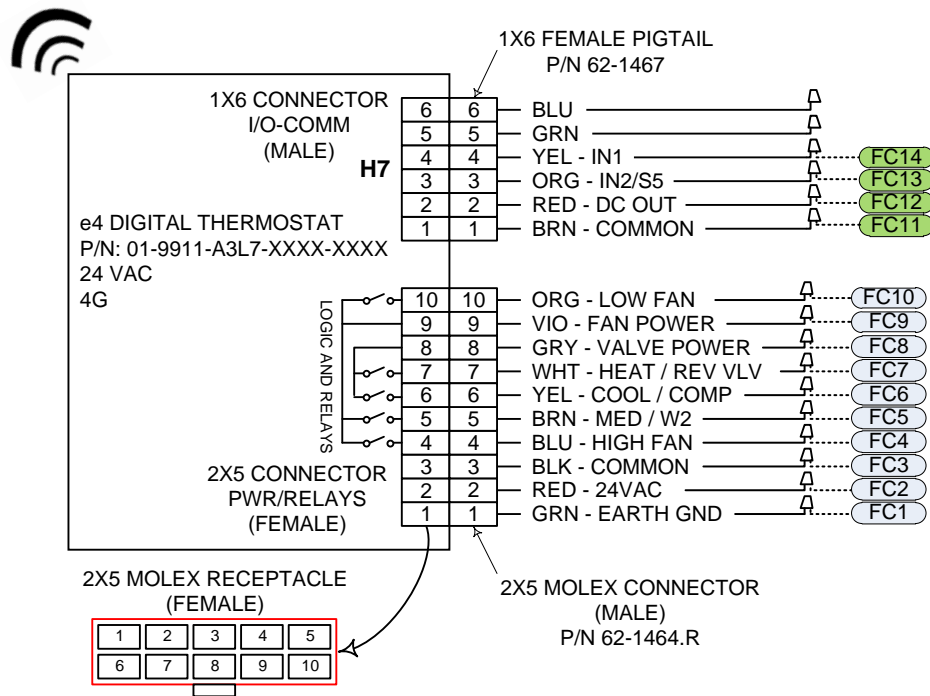

2. Thermostat wire connections:

HVAC INTERFACE

Connection	Color	Function
FC1	Green	EARTH GROUND
FC2	Red	24 VAC POWER
FC3	Black	24 VAC COMMON
FC4	Blue	HIGH FAN RELAY
FC5	Brown	MED FAN RELAY/ HEAT RELAY(STAGE 2)
FC6	Yellow	COMPRESSOR CONTACTOR
FC7	White	HEAT RELAY(STAGE 1)/ REVERSING VALVE
FC8	Grey	24 VAC VALVE POWER
FC9	Violet	24 VAC FAN POWER
FC10	Orange	LOW FAN RELAY

LOW VOLTAGE INTERFACE

Connection	Color	Function
FC11	Brown	DC GROUND
FC12	Red	DC OUT
FC13	Orange	S5 BUS / INPUT 2
FC14	Yellow	INPUT 1

3. System Specific Wiring Guides

Generic Single Stage Heat/Cool

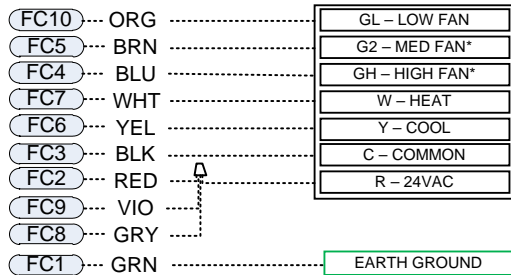

Unused Fan Outputs

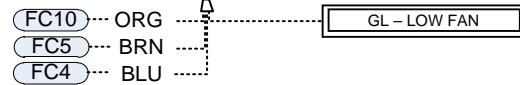

*Unused fan outputs in any HVAC Type shall be tied to FC10

Heat Pump North (HpO)-Single Stage Heat

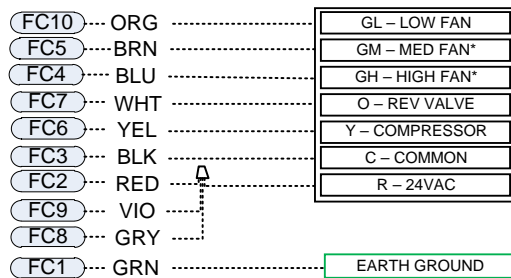

Heat Pump North (HpO)-Two Stages Heat

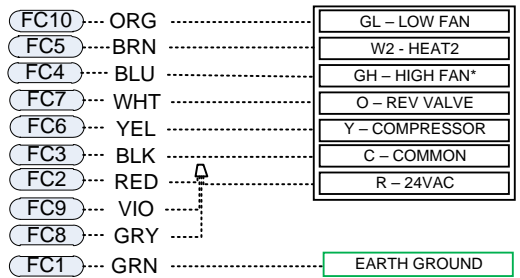

Heat Pump South (HpB)-Single Stage Heat

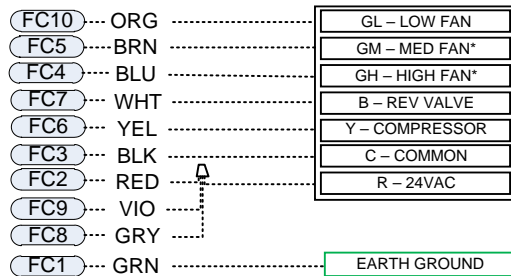

Heat Pump South (HpB)-Two Stages Heat

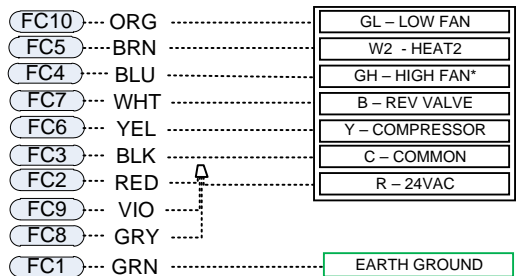

2 Pipe Change-Over

2 Pipe Change-Over with Back-up Electric Heat

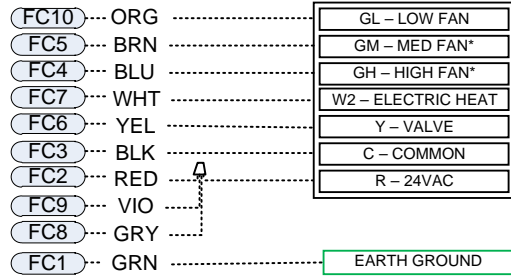
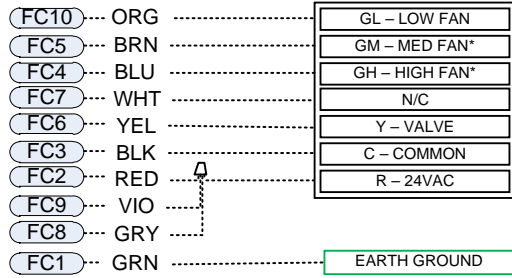

Cool Only System

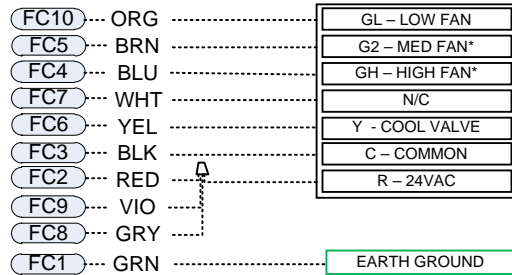

Heat Only System

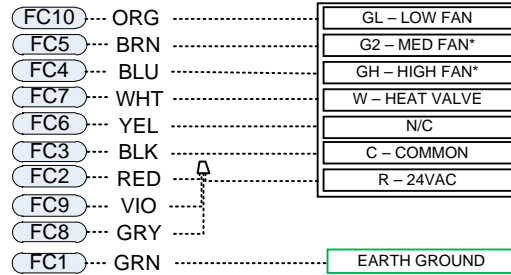

4. Low Voltage Wiring

Door Contact Only

Closed Door=Closed Contact

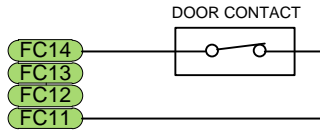

Window Contact Only

Closed Window=Closed Contact

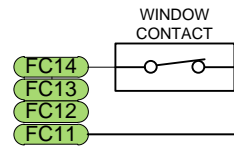

Door & Window Contact

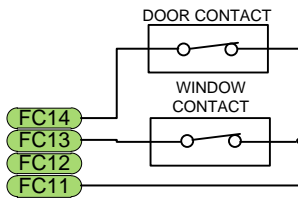

Window Contact & PIR Sensor

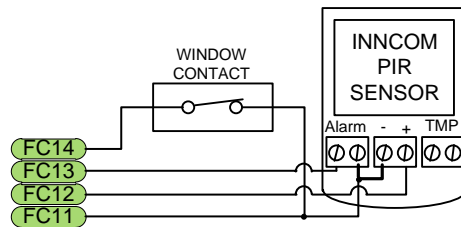

Door Contact & PIR Sensor

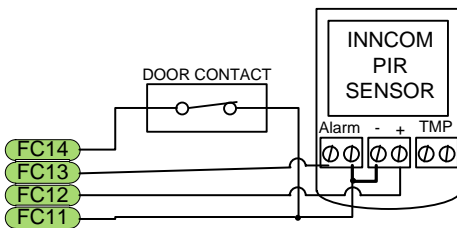

PIR Sensor Only

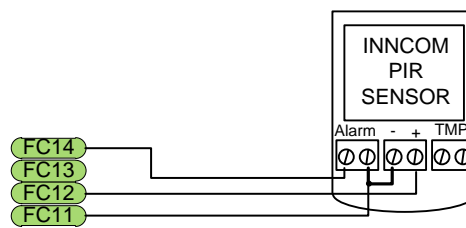

If Multiple Window Contacts in Series

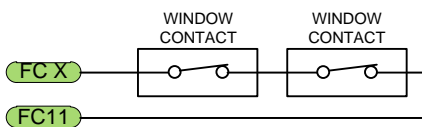

If Multiple PIR Sensors in Series

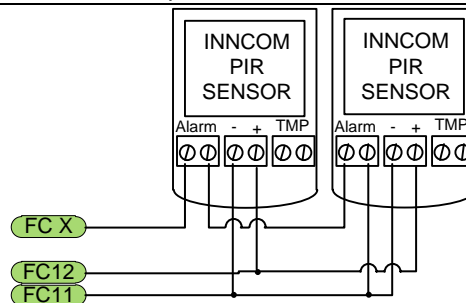

Remote Thermistor

S5 Bus

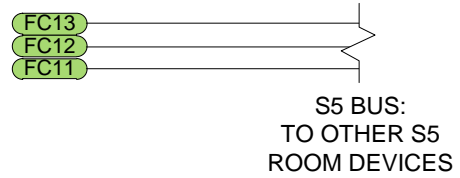
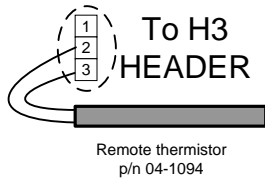

5. Document Information

Author

Christopher Adams

INNCOM by Honeywell
277 West Main Street
Niantic, CT 06357
(860) 739 4468

File

Source:

\$/FO_100_INNtool/Documents/Wiring Guides/INNtool_E528_24VAC_Wiring_Diagram.doc

Distribution:

T:\FTP\Eng_Data\Hotels\FO_100_INNtool\Documents\Wiring Guides\INNtool_E528_24VAC_Wiring_Diagram.pdf

Version

2015/04/21 Version 3.1