

---

# INNCOM e7 Thermostat Wiring Diagrams

---

**This document contains**

A more comprehensive set of wiring diagrams for the e7 Thermostat

---

**Content**

---

<b>1. GENERIC FCU: 24VAC .....</b>	<b>3</b>
<b>2. GENERIC FCU : 100-277VAC .....</b>	<b>3</b>
<b>3. HPB SINGLE STAGE HEAT: 24VAC .....</b>	<b>4</b>
<b>4. HPO SINGLE STAGE HEAT: 100-277VAC .....</b>	<b>4</b>
<b>5. HPO TWO STAGE HEAT: 24VAC .....</b>	<b>5</b>
<b>6. HPB TWO STAGE HEAT: 100-277VAC .....</b>	<b>5</b>
<b>7. VFD AND HEAT/COOL: 24VAC.....</b>	<b>6</b>
<b>8. VFD AND HEAT/COOL: 100-277VAC.....</b>	<b>6</b>
<b>9. 2 FAN SPEED AND 0-10V VALVE: 24VAC .....</b>	<b>7</b>
<b>10. 2 FAN SPEED AND 0-10V VALVE: 100-277VAC.....</b>	<b>7</b>
<b>11. 1 FAN SPEED AND TWO STAGE HEAT/COOL: 24VAC .....</b>	<b>8</b>
<b>12. 1 FAN SPEED AND TWO STAGE HEAT/COOL: 100-277VAC .....</b>	<b>8</b>
<b>13. 1 FAN SPEED HEAT PUMP-2 STAGE COMPRESSOR AND AUX HEAT: 24VAC .....</b>	<b>9</b>
<b>14. 1 FAN SPEED HEAT PUMP-2 STAGE COMPRESSOR AND AUX HEAT: 100-277VAC .....</b>	<b>9</b>
<b>15. 2 PIPE CHANGE-OVER WITH ELECTRIC HEAT: 24VAC .....</b>	<b>10</b>
<b>16. 2 PIPE CHANGE-OVER WITH ELECTRIC HEAT: 100-277VAC.....</b>	<b>10</b>
<b>17. DOCUMENT INFORMATION AND REVISION HISTORY .....</b>	<b>10</b>

---

### 1. Generic FCU: 24VAC

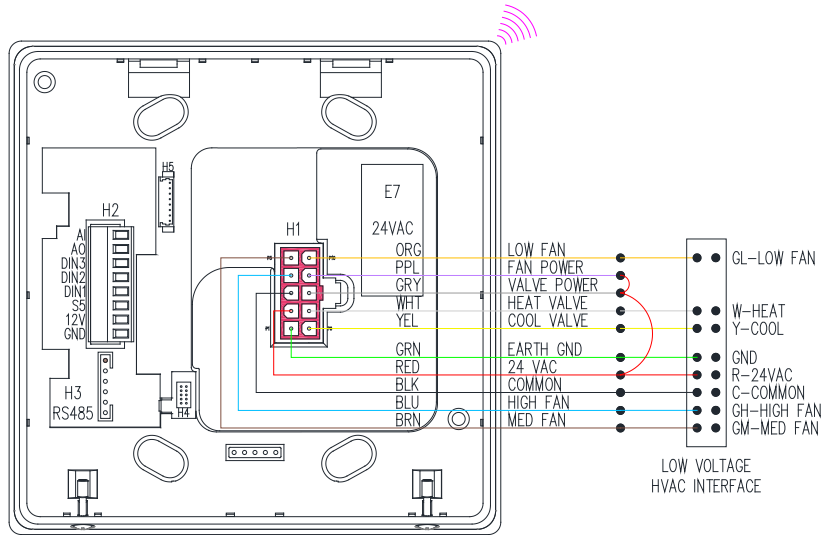

### 2. Generic FCU : 100-277VAC

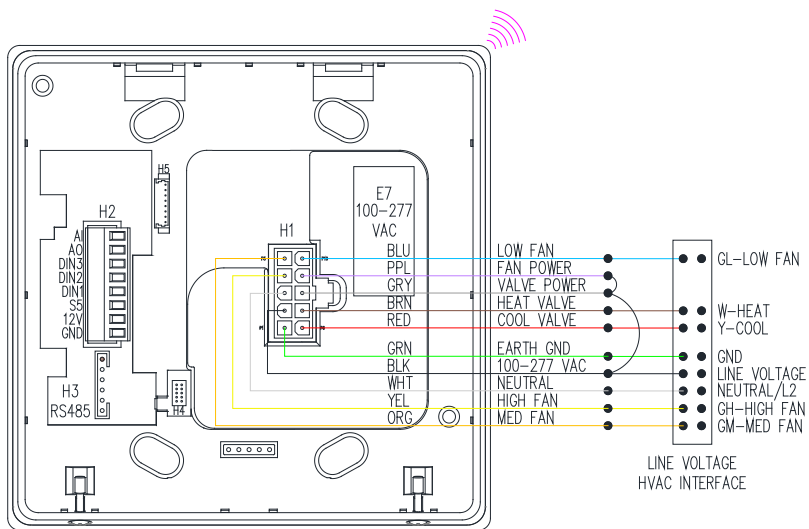

### 3. HpB Single Stage Heat: 24VAC

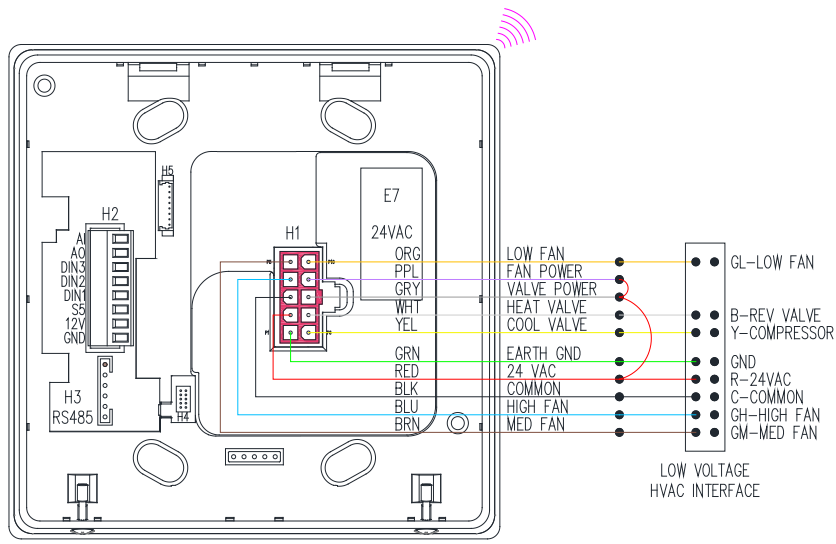

### 4. HpO Single stage Heat: 100-277VAC

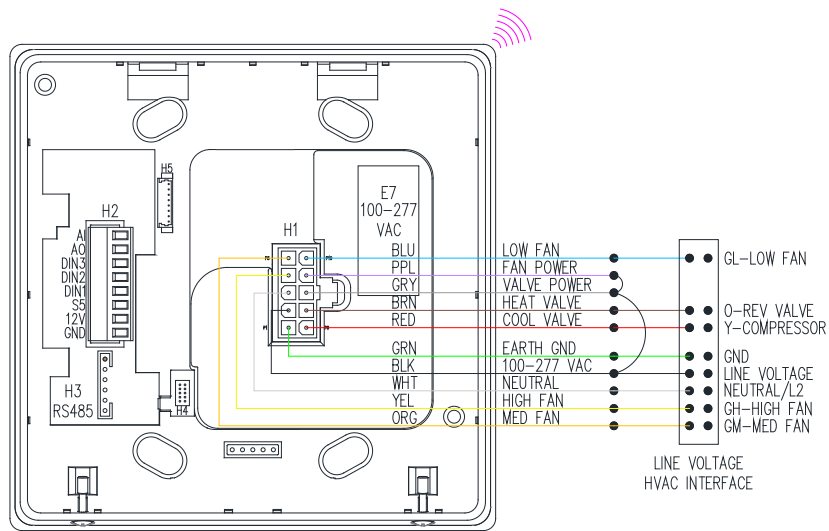

### 5. HpO Two stage Heat: 24VAC

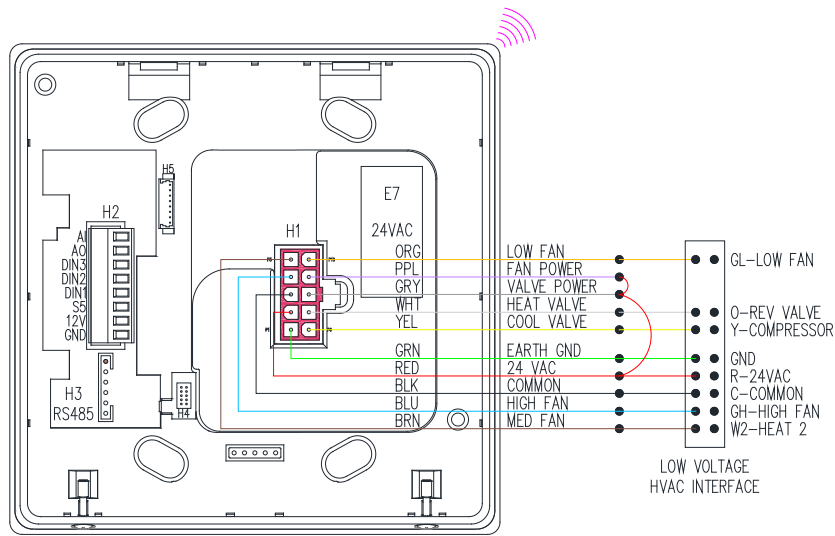

### 6. HpB Two stage Heat: 100-277VAC

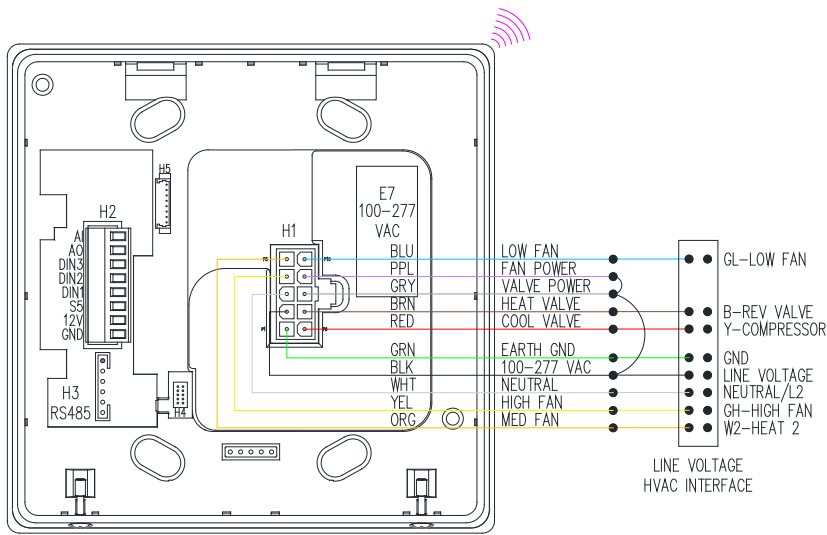

### 7. VFD and Heat/Cool: 24VAC

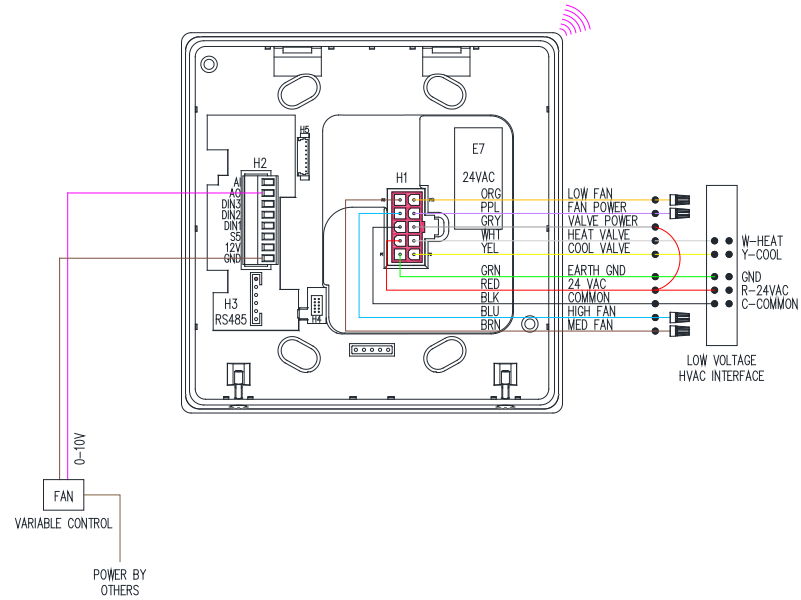

### 8. VFD and Heat/Cool: 100-277VAC

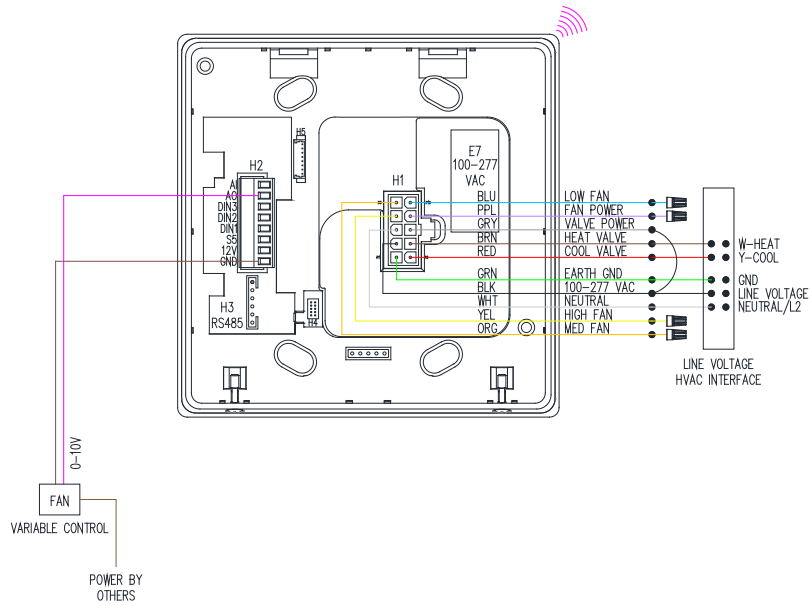

### 9. 2 Fan Speed and 0-10V Valve: 24VAC

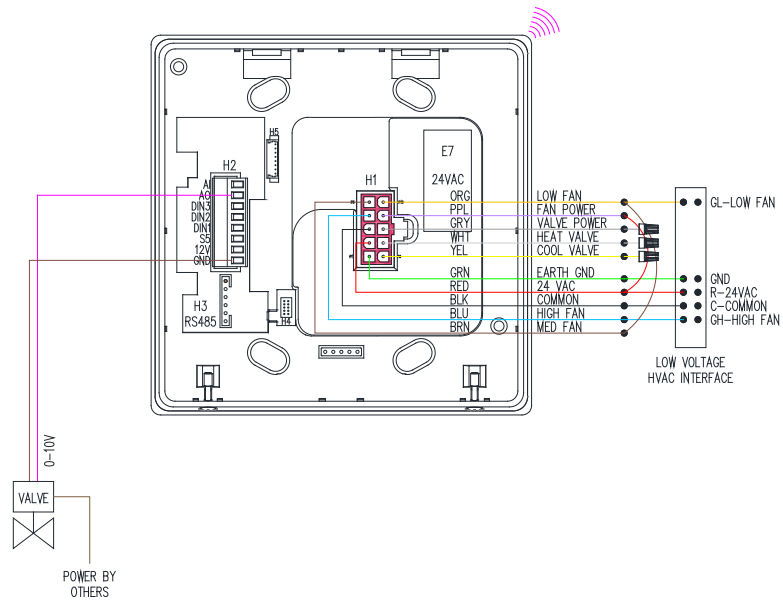

### 10. 2 Fan Speed and 0-10V Valve: 100-277VAC

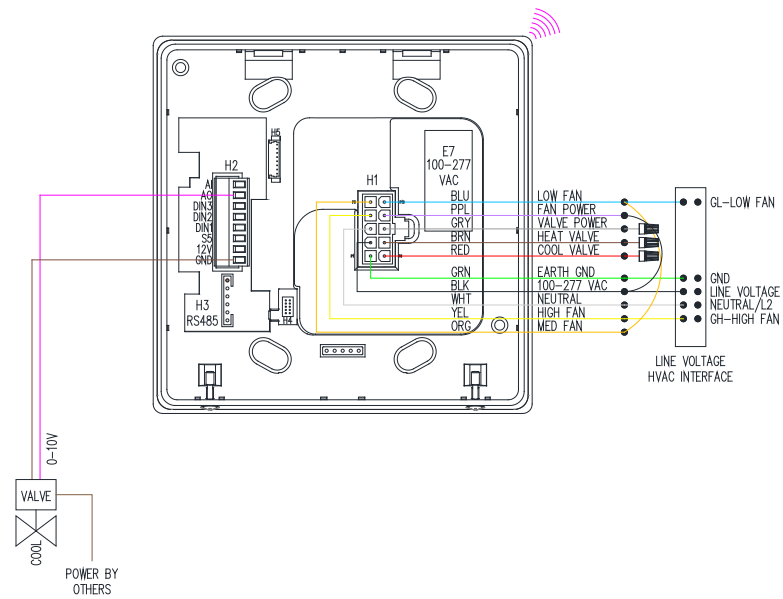

### 11. 1 Fan Speed and Two stage Heat/Cool: 24VAC

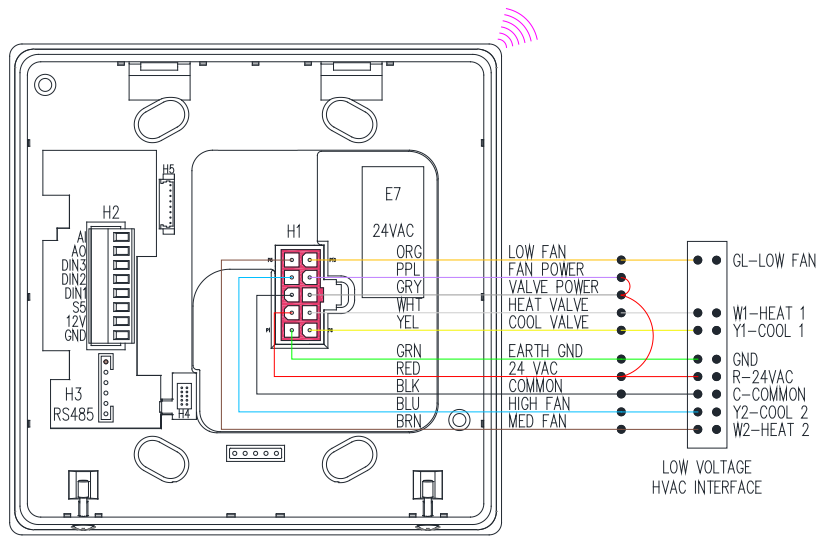

### 12. 1 Fan Speed and Two stage Heat/Cool: 100-277VAC

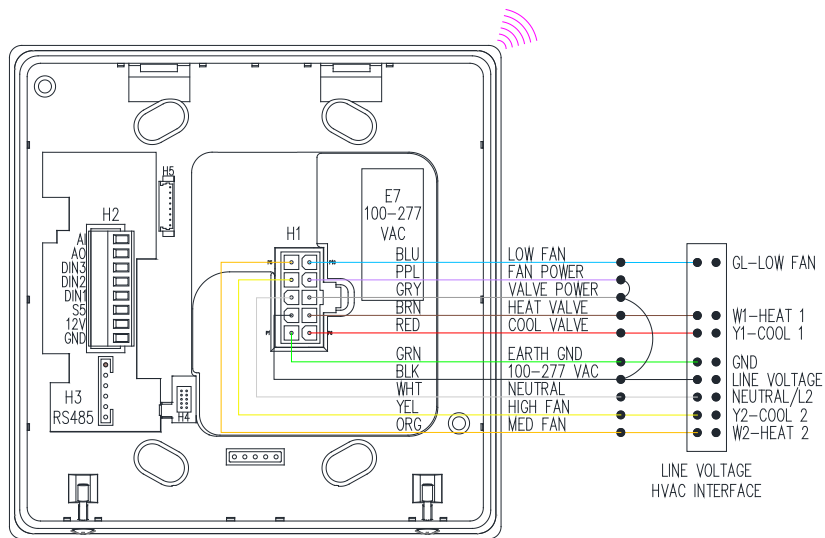



### 13. 1 Fan Speed Heat Pump-2 stage compressor and Aux Heat: 24VAC

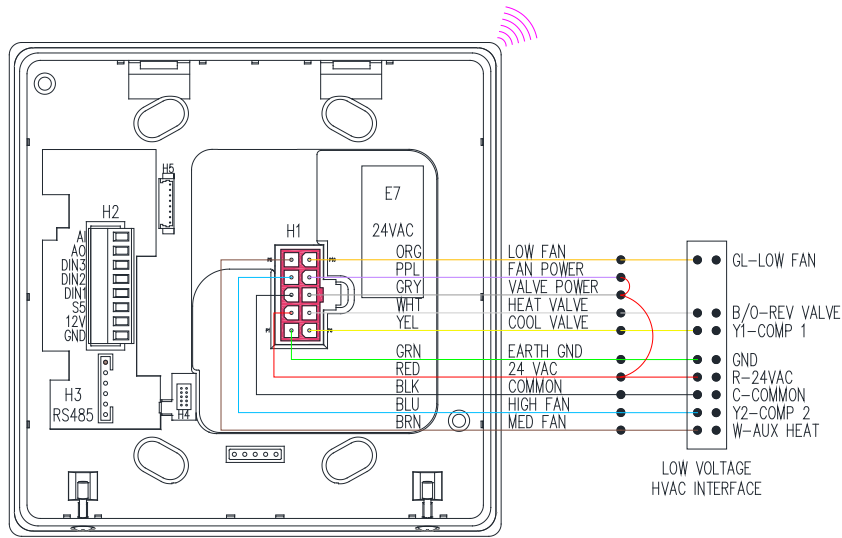

### 14. 1 Fan Speed Heat Pump-2 stage compressor and Aux heat: 100-277VAC

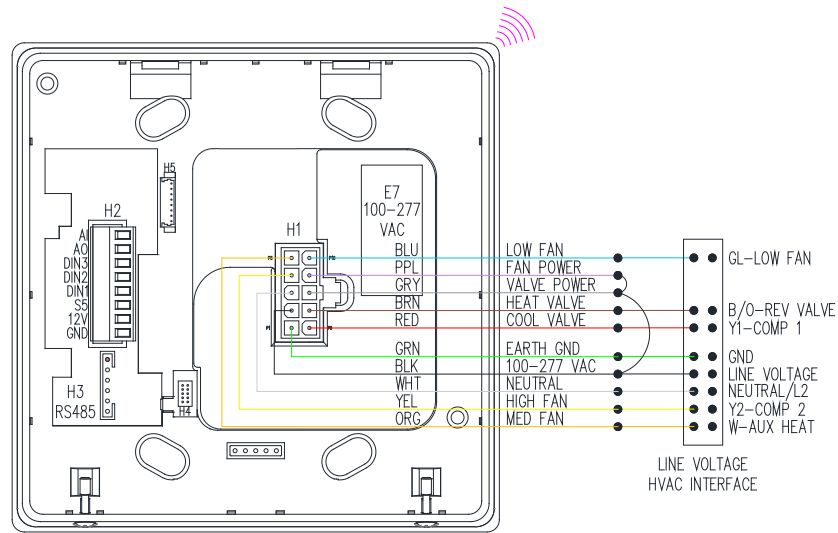

### 15. 2 pipe change-over with Electric Heat: 24VAC

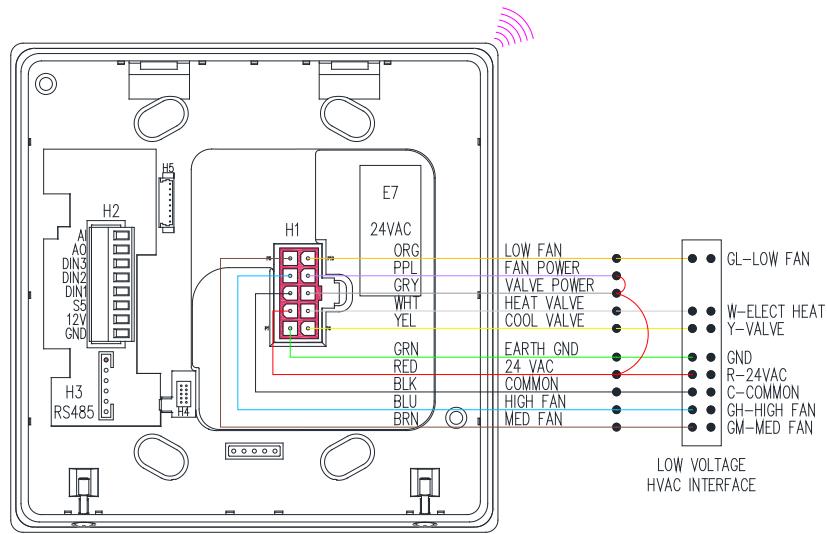

### 16. 2 pipe change-over with Electric Heat: 100-277VAC

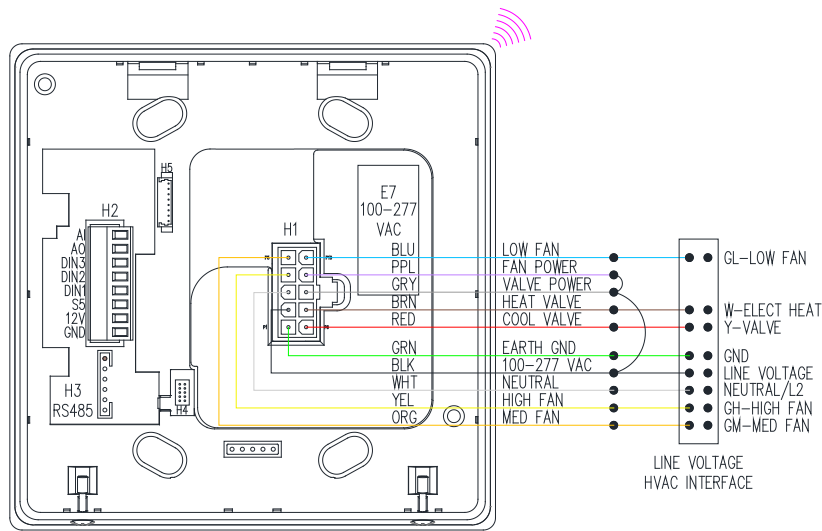

## 17. Document Information and Revision History

Author Ryan Gardner  
 Date Thursday, February 08, 2018

Date	Changes
2011/01/01	First Release